



Modeling and Identification Based On CAN Network Information in Iranian Cars

Javad Sharifi¹, Fereshte Vaezi²

¹ Assistant Professor Electrical and Computer Engineering Department, Qom University of Technology, Qom, Iran

² MSC Student Electrical and Computer Engineering Department, Qom University of Technology, Qom, Iran

ARTICLE INFO

ABSTRACT

Article history:

Received : 29 December 2018

Accepted: 17 May 2019

Published: 01 June 2019

Keywords:

Fuzzy Control
LS Estimation
IKCO
CAN Communication
Network
Automation

Modeling and identification of the system of Iranian cars is one of the most basic needs of automotive and consumer groups and has a broad role for safe driving. It has happened with speed increasing or changing of shift gear, effects on water temperature or the car's torque has been observed, but how much and how intensely and with what algorithm this effect is identifiable, can be modeled and controlled, because up to now an algorithm that can show these effects during driving has not existed that what reaction should be made by the vehicle when it occurs untimely.

Identification of each automobile sector lonely has been considered in recent decades, and in some cases, some relationships have been investigated, but from a control point of view, the lack of comprehensive effects of all parts of a car on the other parts is to get an identification algorithm in the automotive industry, and it requires more in-depth studies, because the complexity of the behavior of different parts of the car has made many attempts not fully understandable. Hear it's supposed to control different parameters of Iranian vehicles by using LS estimation and fuzzy logic controller and the simulation is done in Matlab software by storing and validating data of a Dena vehicle through CAN network.

* Javad Sharifi

Email Address: sharifi@qut.ac.ir

1 Introduction

Before doing any work, you need to know the network of automotive systems, how to send and receive information in it, to examine the data and analyze the physical relationships governing them by sampling the network in a variety of vehicles, having Information such as configuring nodes of vehicle systems, recognizing network layers, the number of bits sent for each frame and signal, and calculating the output of each signal, through MATLAB software, to have a model for analyzing different parts of the vehicle on each other while driving. Various activities have been undertaken in the field of control engineering in a variety of vehicles, for example LPV/ \mathcal{H}_∞ controller for suspension system designed to adapt the vehicle vertical dynamics to the lateral dynamics and achieve performance objectives [1]. PI control systems to control the actual HV battery power in power-split HEV, which can sometimes result in either overshoots of engine speed and power or degraded response and settling times due to the nonlinearity of the power-split hybrid system [2]. An innovative method for estimating the roll angle in two-wheeled vehicles is proposed [3]. The L_2 -gain method of disturbance suppression, the nonlinear h_{∞} output feedback controller is designed for the integrated system of EPS/ASS with considerations of random road input and strong crosswind disturbance [4]. An adaptive slid mode controller was established for improving the handling stability of MEV. First, the structure and advantages of electric vehicle driven by in-wheel motors was provided. Then, an ideal cornering model of vehicles was brought and analyzed, after which a method to estimate side-slip angle was also proposed and three typical sensors were used. [5]. Using the SOSM methodology to guarantee robust stability in front of disturbances and model uncertainties, which are typical of the automotive context. A feed forward control contribution is also employed to enhance the transient system response [6]. Using brake torque for improving vehicle performance and stability especially in high speed driving. Its characteristics is that only one brake is used for control depending on the vehicle state. Steering angles are modeled as a disturbance input to the system and the

controller minimizes the difference between the performance of the actual vehicle behavior and that of its 'model' behavior under the disturbance input .[8] and Stability Control of Electric Vehicles that is done in some other papers.[9],[10],[11]

All automotive control methods have been implemented a specific vehicle segment, and none of them have been modeled on automotive parts of the vehicle network to identify and estimate various car parameters, such as engine speed, fuel consumption and temperature, and the creation of algorithm and the specified model have not been addressed.

2 Automation

The word "automation" was first used in the early 1940s to name the processes in which various mechanisms were used to perform tasks that previously required the supervision, intervention, and control of mankind. Since then, the term has been used for a large group of automata and automation systems, and generally refers to all cases in which human intelligence or human action in its mechanical, chemical, and electrical reactions plays its role essentially instead. It can be named an automated process that is more automatic than its ancestors. Automation in the broadest concept is divided into production and services. Automation of production includes automation in the field of machine tools for the production of components, automatic assembly machines, automatic processing, industrial robots, automatic monitoring systems, feedback control systems, computer systems for designing products and their analysis, computer systems for direct conversion of design to the product automatically, computer systems for design and production support decision. From another perspective, automation can be categorized as programmable automation and flexible automation.

The first type involves the use of common engineering tools to automate a constant process or alignment operation. This type of automation is sometimes named as a hard automation. In the second type of automation, any particular modification in the product cycle can be applied, which this type of change can be done by changing the input program. After producing a

certain volume of a series of production, by changing the program, it produced a new sample for a new series. Today's specimen can be called a CNC machine.

And in the third type, the tools are designed in a way that can produce a variety of products and spend a little time to make changes to change product types.

Therefore, a flexible production system can be used to produce various combinations of products based on any given program. This type of automation allows the manufacturer to produce several products instead of one at a lower cost. In this paper we are supposed to estimate different parameter of a DENA car of IRAN KHODRO Company to reach to a specific algorithm by using data of CAN network of DANA car with CAN network through LS estimation. [12], [13], [14]

3 CAN NETWORK

3.1 Introduction Of CAN Bus

CAN network is a controller network and plays a major role in the development of the automotive industry, as technology was expanded from computers to control and protect motor and safety systems and over time, more computers (ECUs) were used in cars. ECU means electronic control unit, and the number of electronic control units used in vehicles is constantly increasing and it is necessary to connect these control units to a network, for this purpose the best way is to use of a CAN computer network.



Figure 1. CAN Connection

The CAN bus is a communication system in which every ECU must know that the bus is not occupied before sending data. This process is known as CSMA / CD. Simply a system

connects to ECUs, and all ECUs compete with each other in this process to share data and use it in common. When the ECU wants to send data to the bus and the bus is busy, it waits for the bus to be empty and then sends its data.

In the bus system, if multiple ECUs simultaneously want to exchange data, the collision of this data will cause the data to be lost, so a prioritization system specifies that the data that is more important and has the first priority is sent first and then allows the rest of the data to be sent in turn. For example, wheel speed has a high priority, because it is related to the safety of the vehicle, and the engine's temperature is less than that. In this way, some of the data that has the lowest priority may be sent by more delay, in order to prevent such a disruption of data, lower-priority data can be sent through a CAN bus separately. And this bus connects to a higher priority bus through a gateway, which acts like a filter to filter data between the lower-priority and the higher priority bus. [15], [16]

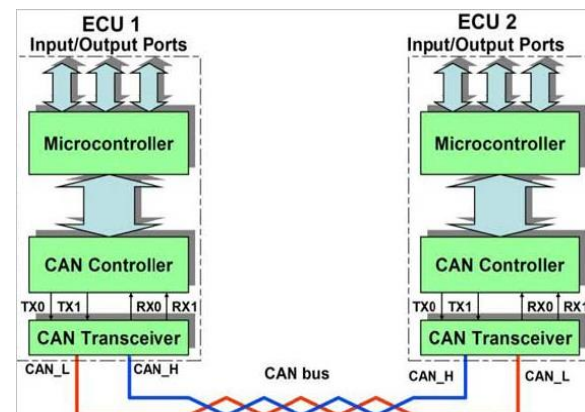

Figure 2. Connection between ECU and CAN Bus

3.2 ECU Connection With CAN Bus

In today's cars, most ECUs can be connected to other parts of the network through a CAN bus. The ECU structure consists of a microcontroller and a network interface, which itself includes the CAN bus control and CAN / transmitter / receiver. The microcontroller is in fact the controller's main part, which includes a control program, for example a motor or a suspension system, and the CAN controller can control the network's communication to take the necessary

data from microcontroller to be sent to another ECU and also data can be converted to a standardized way in accordance with CAN bus and transmitter / receiver of electrical signals that should be sent to the bus will be receive or generates. Connecting a CAN bus control to a microcontroller is similar to connecting an Ethernet interface to a computer. [13], [14]

3.3 CAN Template And Its Data Field

When the control data is sent to another ECU, the microcontroller sends this data to the CAN controller, where the information is in a specific frame, in such a way to determine where the destination is and change the data that is understandable to the destination. Any data that is sent has an identifier and a size that the ID indicates to what information is and where it will go, for example, it contains information about fuel, gasoline, etc. The end of the template is specific for errors.

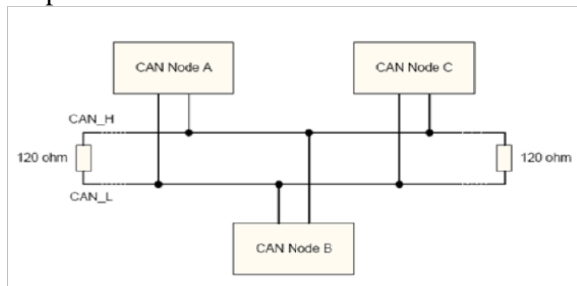

Figure 3. Wiring In CAN Network

For example, if the engine ECU sends the engine speed to the gearbox ECU to indicate that the gear has been changed, the gearbox ECU must send gearbox status data to the engine ECU in order to ensure about safe and smooth gear shifting. Two ECUs can exchange data through a pair wire of CAN buses in frame template. CAN bus basically is a pair twisted of wires to protect from electrical noise. When the data is to be sent, the CAN sender in the ECU produces a pulse and differential signal, that the sum of them is equivalent to the final signal, or the CAN template. CAN_H and CAN_L are in fact one signal with reverse polarity, so they are called a differential. When the bus is empty, CAN_H and CAN_L have equal voltage values

equal to 2.5 V and in the opposite direction, their total value is zero and when a frame is sent, CAN_H value increases and CAN_L value decreases thus it is detected on the receiver side, that the total signal is no longer zero. Data sending by this method simplifies the noise elimination because each noise that is existed on CAN_H, the same noise will be in the opposite direction, so the total does not change, so the noise is virtually eliminated. [17]

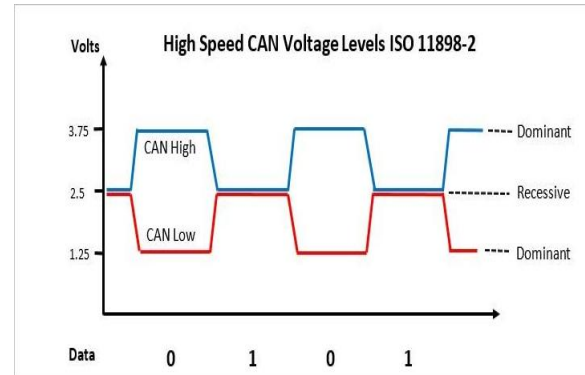

Figure 4. CAN/HS And CAN/LS Voltage Level

3.4 CAN Network Frame In A DENA Vehicle

Name	Description
CCN	Central Communication Node
EMS	Engine Management System
ABS	Antilock Braking System
TCU	Transmission Control Unit
ESP	Electronic Stability Program
EPAS	Electric Power Assistant Steering
SAS	Steering Angle Sensor

Figure 5. CAN/HS Powertrain database specification [6]

EMS TX message	ABS TX message	CCN TX message	EPAS TX message	SAS TX message	TCU TX message
EMS1	ABS1	CCN-HS1	MDSP1	SAS1	TCU1
EMS2	ABS2	CCN-HS2	EPAS_SUP	SAS_SUP	TCU_SUP
EMS6	(ESP)BRAKE1	CCN-HS4			
EMS7	ABS_ESP_SUP	CCN_SUP			
EMS8					
EMS9					
EMS_SUP					

Figure 6. CAN/HS messages and signals

Name	Identifier	Dlc	Lmin	Period	Transmitter	Receivers
ABS1	1F1h	8	8	20ms	ABS or ESP	CCN – EMS – TCU – EPAS
ABS2	1F2h	8	8	200ms	ABS or ESP	EMS-CCN
ABS_ESP_SUP	681h	6	6	1000ms	ABS	Data loggers
BRAKE1	1F3h	8	8	20ms	ESP	CCN - EMS
CCN_HS1	600h	5	5	10ms	CCN	CCN – EMS – TCU – EPAS – SAS – ABS or ESP
CCN_HS2	601h	1	1	5000ms	CCN	EMS
CCN_HS4	110h	1	1	Event	CCN	EMS
CCN_SUP	683h	6	6	1000ms	CCN	Data loggers
EMS1	200h	8	8	10ms	EMS	TCU – ESP
EMS2	201h	3	3	10ms	EMS	CCN – TCU
EMS6	1C1h	8	8	10ms	EMS	CCN – TCU – ESP – EPAS
EMS7	1C2h	3	3	10ms	EMS	CCN
EMS8	1C3h	2	2	20ms	EMS	CCN
EMS9	1C4h	6	6	10ms	EMS	TCU – ESP
EMS_SUP	684h	6	6	1000ms	EMS	Data loggers
MDSP1	5E4h	3	3	100ms	EPAS	CCN
EPAS_SUP	685h	6	6	1000ms	EPAS	Data loggers
SAS1	2B0h	5	5	10ms	SAS	ESP – EPAS
SAS_SUP	686h	6	6	1000ms	SAS	Data loggers
TCU1	500h	8	8	10ms	TCU	CCN – EMS – ESP
TCU_SUP	687h	6	6	1000ms	TCU	Data loggers

Figure 7. Database messages

In general, the names of the different parts used in the car are used briefly in the table 1. In table 2, all frames used in the high-speed network are gathered. In table 3, an example of the frames with their specifications, such as: id¹, period, sender and receiver, DLC² is shown. And in table 4, there is an example of the location of the signals related to the frame ABS1 in the corresponding format [18].

3.5 Physical Relationship

The formula below converts the hex values obtained from can network to the relations governing the signals simply by considering the offset and the resolution, in table 5, an example of the Hex code conversion, the cruise control signal is shown [18].

$$Q(\text{value}) = \text{Can}(\text{value}) * \text{factor} + \text{offset} \quad (1)$$

Desired-cruise-speed (KM/H)	0	60	120	240	511/75
Hex Code	0X000(MIN)	0X1E0	0X3C0	0X780	0XFFE(MAX)

Figure 8. EMS2/Desired-cruise-speed

3.1 CAN Analyzer³ Software

To save can network data from a Dena vehicle, CAN analyzer software, CAN hardware and communication cables are needed then the stored data will be reviewed in offline mode, for this purpose, first of all, the can hardware, which is shown in Fig and has two LS⁴ and HS⁵ ports that is connected to a CAN_HS and CAN_LS output of a car.

¹ identifier

² Data length

³ CANalyzer

⁴ Low Speed

⁵ High Speed

	Bit7	Bit6	Bit5	Bit4	Bit3	Bit2	Bit1	Bit0
Byte0	Free	EBD_Active	ABS_DIAG	EBD_Warning_Lamp	ABS_Warning_Lamp	ABS_Active	EBD_Error	ABS_Error
Byte1	Free							
Byte2	WHEEL_SPEED_FL_LSB							
Byte3	WHEEL_SPEED_FR_LSB				WHEEL_SPEED_FL_MSB			
Byte4	WHEEL_SPEED_FR_MSB							
Byte5	WHEEL_SPEED_RL_LSB							
Byte6	WHEEL_SPEED_RR_LSB				WHEEL_SPEED_RL_MSB			
Byte7	WHEEL_SPEED_RR_MSB							

Figure. 8. Database layout ABS1 message

In this test, due to the need of CAN-HS network, only the connections of HS port has been checked and not to be needed to connect to another port. It should be noted that if both ports are connected to the car, it will be faced a large value of data which are not necessary for this test and then CAN_LS data should be filtered, so it's better not to connect the LS port at all. For storing data from the CAN network, the following should be considered:

- 1) Hardware connections are connected accurately. The HS and LS ports of the car are connected to CHANNEL1 and CHANNEL2 of hardware respectively, and ensure the integrity of the cable between the computer and the CAN hardware. Install the CANalyzer software correctly, and then install the CAN_HS and CAN_LS database software at the location shown in fig.12

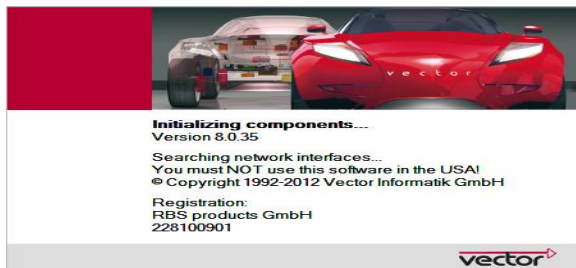

Figure 9. CANalyzer Software Startup

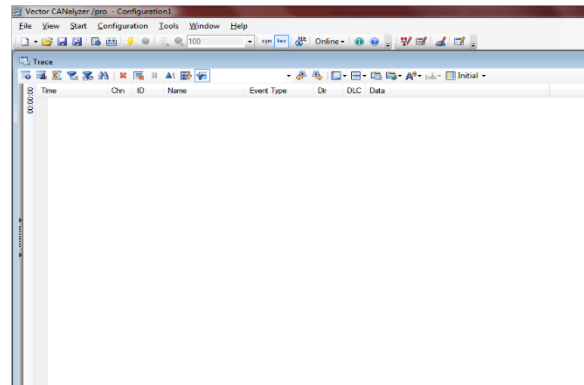

Figure 10. CANalyzer Software Window

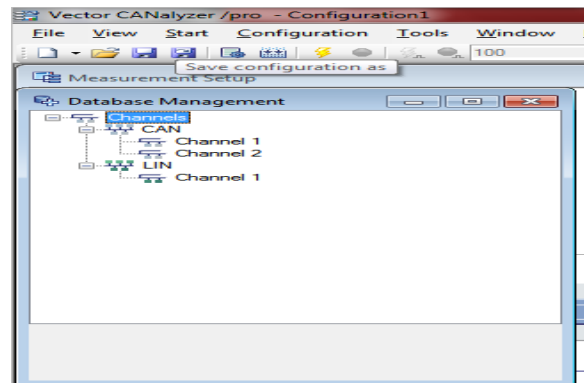

Figure 11. Database Management In CANalyzer Software

- 2) Set the send bit rate, for CAN_HS, set the value to 500000, and for CAN_LS, 125000

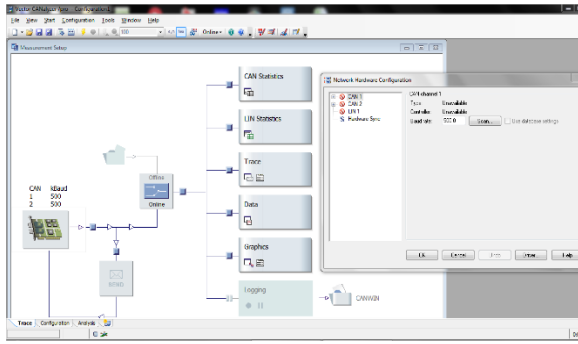

Figure 12. Baud Rate Management In CANalyzer Software

3) Enter to the setup menu and activate the logging section and set the path and name for the stored data.

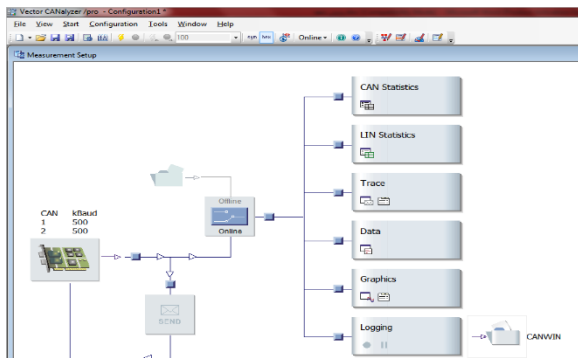

Figure 13. Logging Management In CANalyzer Software

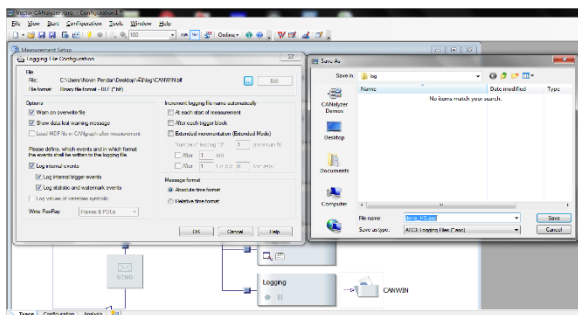

Figure 14. Saving Log File In Special Place

4) While storing information, be careful that the start switch of car is in start mode and the speed of the vehicle is testing in all gear position and the data is storing simultaneously and then after some minute stop the logging process.

5) You do not need hardware to view stored data anymore. By inserting CANalyzer software into

an offline mode and adding a log which is stored before, analysis will be possible.

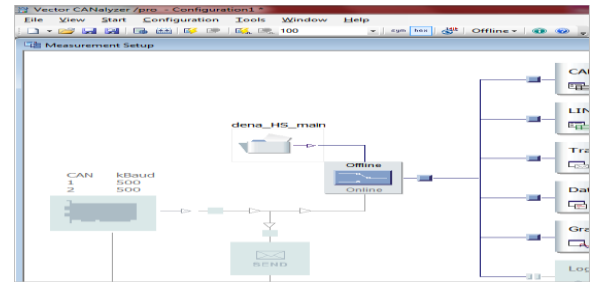

Figure 15. Analyzing Log File In Offline Mode Of Software

6) When the log is started, it can be seen that any CAN frame is sent as a packet data and CAN signals are not accessible.

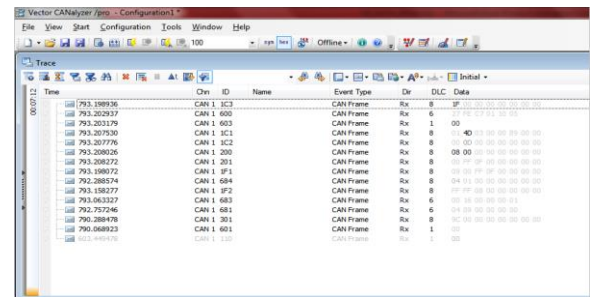

Figure 16. CAN Log Started In Offline Mode

7) To solve the problem, select the graphic in the view window and then, in open page, add the required signals, finally, right-click on the page and click on Export, the decimal value of all the signals is stored in the excel file by calculating the software and considering the period of signals itself.

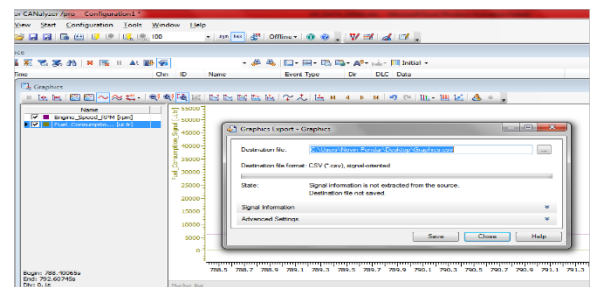

Figure 17. Making Excel File Of Stored Data

4 SYSTEM IDENTIFICATION

4.1 Introduction

System identification is the modeling of systems which its equations are known in accordance with physical laws. These systems can be electrical, mechatronic, robotic or chemical.

When we interact with a system, we need some concept of how its variables relates to each other. With abroad definition, we shall call such an assumed relationship among observed signals a model of a system. Clearly models will come in clear shapes and be phrased with varying degrees of mathematical formalism.

The intended use will determined the degree of sophistication that is required to make the model purposeful. In daily life many systems are dealt with using mental models, which don't involve any mathematical formalization at all. To drive a car for example, requires the knowledge that turning the steering wheel to the left induces a left turn, together subtle information built up in a muscle memory. The importance and degree of sophistication of the latter should of course not be underestimated.[19]

For certain systems it is appropriate to describe its properties using numerical table's plots. Linear systems, can be uniquely described by their impulse or steps responses or by their frequency functions. Graphical representation of these are widely used for various design purposes. The nonlinear characteristic of, say, a valve are also well suited to be described by a graphical model.

For more advanced applications, it may be necessary to use models that describe the relationship among the system variables in terms of mathematical expressions like difference or differential equations, such models are called mathematical or analytical models. Mathematical models may be further characterized by a number of adjectives (time continuous or time discrete, lumped or distributed, deterministic or stochastic, linear or nonlinear, etc.) signifying the type of difference or differential equation used. The use of mathematical models is inherent in all fields of engineering and physics. In fact, a major part of the engineering field deals with how to make good designs based on mathematical models.

They are also instrumental for simulation and forecasting which is extensively used in all fields, including in non-technical areas like economy, ecology and biology.

A model used in computer simulation of a system is a program. For complex systems this program may be build up by many interconnected subroutines and lookup tables, and it not be feasible to summarize it analytically as a mathematical model. We use the term software model for such computerized descriptions. They have come to play an increasingly important role in decision making for complicated systems, so systems may have a very complex and large mathematical model, or they have no model at all, such as the behavior of the sun and stars, weather conditions, sea behavior, Interaction of the fling object in different conditions of aerodynamics, social behavior, price situation of expensive metals, stock market, urban traffic behavior, etc. These models are strongly dependent on intelligence data. System identification can be implemented in a variety of static, dynamic, classic and smart nonlinear systems.

Buildings models:

Basically, a model has to be constructed from observed data. The mental model of car-steering dynamics, for example, is developed through driving experience. Graphical models are made up from certain measurements. Mathematical models may be developed along two routes (or a combination of them). One route is to split up the system, figuratively speaking, into subsystems, whose properties are well understood from previous experience. This basically means that we rely of "laws of nature" and other well-established relationships that have their roots in earlier empirical work. These subsystems are then joined mathematically and a model of the whole system is obtained. This route is khom as modeling and does not necessary involve any experimentation on the actual systems. The procedure of modeling is quite application dependent and often has its roots in tradition and specific techniques in the application area in question. Basic techniques typically involve structuring of the process into block diagrams with blocks consisting of simple elements. The reconstructions of the system from these simple blocks id now increasingly

being done by computer, resulting in a software model rather than a mathematical model.

The other route to mathematical as well as graphical models is directly based on experimentation. Input and output signals from the systems, are recorded and subjected to data analysis in order to infer a model. This route is system identification.[19]

The fiction of a true system:

The real-life actual system is an object of a different kind than our mathematical models. In a sense, there is an impenetrable but transparent screen between our world of mathematical descriptions and the real world. We can look through this window and compare certain aspects of the physical system with its mathematical description and the real world. We can never establish any exact connection between them. The question of nature's susceptibility to mathematical description has some deep philosophical aspects, and in practical terms we have to take a more pragmatic view of models. Our acceptance of models should thus be guided by "usefulness" rather than "truth". Nevertheless, we shall occasionally use a concept of "the true system" defined in terms of a mathematical description. Such a fiction is helpful for devising identification methods and understanding their properties. In such contexts we assume that the observed data have been generated according to some well-defined mathematical rules, which of course is an idealization.

The steps to identify a system are:

Three basic Analysis of modeled systems and
analysis of stability, controllability, visibility,
time response and frequency response
Controller design
Realization Implementation

4.2 Identification Steps

- 1- Data Collection⁶: Inputs and Outputs
 - 2- A data classification that includes training data, validation data, and test data.
 - 3- Selection of system identification using educational data
 - 4- Test validity based on data
- Three basic entities

⁶ Data acquisition

The construction of a model from data involves three basic entities:

- 1- The data record. The input-output data are sometimes recorded during a specifically designed identification experiment, where the user may determine which signals to measure and when to measure them and may also choose the input signals. The object with experiment design is thus to make these choices so that the data become maximally informative, subject to constrain that may be at hand. In other cases the user may not have the possibility to affect the experiment, but must use data from the normal operation of the system.
- 2- A set of candidate models. That is obtained by specifying within which collection of models we are going to look for a suitable one. This is no doubt the most important and, at the same time, the most difficult choice of the system identification procedure. It is heard that a priori knowledge and engineering intuition and insight have to be combined with formal properties of models. Sometimes the model set is obtained after careful modeling. Then a model with some unknown physical laws and other well-established relationships. In other cases standard linear models may be employed, without reference to the physical back-ground. Such a model set, whose parameters are basically viewed as vehicles for adjusting the fit to the data and don't reflect physical considerations in the system, is called a black box. Model sets with adjustable parameters with physical interpretation may, accordingly, be called gray boxes.
- 3- A rule by which candidate models can be assessed using the data. Determining the best model in the set, guided by the data. This is the identification method. The assessment of model quality is typically based on how the models perform when they attempt to reproduce the measured data.

Model validation:

After having settled on the preceding three choices, we have, at least implicitly, arrived at a particular model: the one in the set that best describes the data according to the chosen criterion. It then remains to test whether this

model is "good enough" that is, whether it is valid for its purpose. Such tests are known as model validation. They involve various procedures to assess how the model relates to observed data, to prior knowledge, and to its intended use. Deficient model behavior in these respects make us reject the model, while good performance will develop a certain confidence in the model. A model can never be accepted as a final and true description of the system. Rather, it can at best be regarded as a good enough description of certain aspects that are of particular interest to us.

The system identification loop:

The system identification procedure has a natural logical flow: first collect data, then choose a model set, then pick the best model in this set. It is quite likely, though, that the model first obtained will not pass the model validation tests. We must then go back and revise the various steps of the procedure.

The model may be deficient for a variety of reasons:

- The numerical procedure failed to find the best model according to our criterion.
- The criterion was not well chosen.
- The model set was not appropriate, in that it did not contain any good enough description of the system.
- The data set was not informative enough to provide guidance in selecting good models.

The major part of an identification application in fact consist of addressing these problems, in particular the third one, in an iterative manner, guided by prior information and the outcomes of previous attempts [20],[21].

4.3 LS Estimation

The method of least squares is about estimating parameters by minimizing the squared discrepancies between observed data, on the one hand and their expected values on the other the variation in one variable, called the response variable y , can be partly explained by the variation in the other variables, called x . The least squares criterion is a computationally convenient measure of fit.

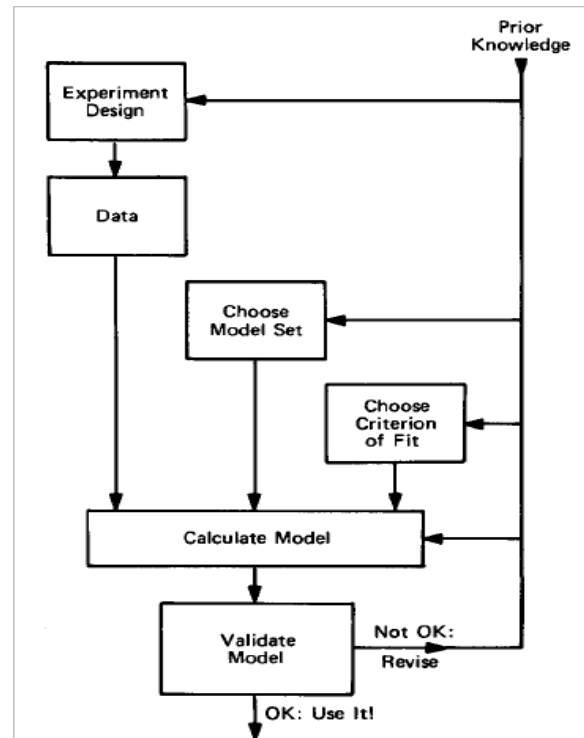

Figure 18. The System Identification Loop

It corresponds to maximum likelihood estimation when the noise is normally distributed with equal variances. Other measures of fit are sometimes used, for example, least absolute deviations, which is more robust against outliers.

Linear Regression:

Consider the case where \hat{y} is a linear function of θ , that is

$$\hat{y} = \theta_1 x_1 + \theta_2 x_2 + \dots + \theta_n x_n = f(x, \theta) = x \cdot \theta \quad (2)$$

$x_1 \dots x_n$ are independent inputs, \hat{y} is output of model and θ is Parameter based on data.

y is data for real output and N is data sample of a system.

To write down the least squares estimator for the linear regression model, it will be convenient to use matrix notation.

$$X = (X_1 \dots X_p) \quad (3)$$

N-dimensional linear model:

$$\begin{aligned} \hat{y} &= \theta_1 x_1 + \theta_2 x_2 + \dots + \theta_n x_n = f(x, \theta) = x \cdot \theta \\ \{x[1] &= [x_1[1] \dots x_n[1], y[1]] \\ &\vdots \\ \{x[N] &= [x_1[N] \dots x_n[N], y[N]] \end{aligned} \quad (4)$$

Error value:

$$e(t) = v(t) - \hat{v}(t) \quad (5)$$

Error = Real value - Measured value = Total squared error - Benchmark for obtaining optimal

$$\text{calculation } \sum e^2(t) = SSE \quad (6)$$

$$e[t] = y[t] - \hat{y}[t] = y[t] - x[t] \cdot \theta$$

$$SSE = \sum_{t=1}^N e^2[t] = [e[1] \dots e[N]] \begin{bmatrix} e[1] \\ \vdots \\ e[N] \end{bmatrix} = e \cdot e^T$$

(7)

The squared distance between the vector y and the linear combination θ of the columns of the matrix x . The distance is minimized by taking the projection of y on the space spanned by the column of x (see Figure 1).

$$y - x\theta = noise$$

$$\|y - x\theta\|^2 \quad (8)$$

Suppose now that x has full column rank, that is, no column in x can be written as a linear combination of the other columns. Then, the least

squares estimator $\hat{\theta}$ is given by

$$\hat{\theta} = (x^T x)^{-1} x^T y \quad (9)$$

least squares (the unknown values of the parameters, $\theta_0, \theta_1, \dots$, in the regression function, $f(x^T; \theta^T)$, are estimated by finding numerical values for the parameters that minimize the sum of the squared deviations between the observed responses and the functional portion of the model. Mathematically, the least (sum of) squares criterion that is minimized to obtain the parameter estimates [22].

$$y = x\theta + noise(n)$$

$$= \frac{1}{N} \sum ((\hat{\theta} - \mu)(\hat{\theta} - \mu)^T) = E((\hat{\theta} - \theta)(\hat{\theta} - \theta)^T)$$

$$(\hat{\theta} - \theta) = (x^T x)^{-1} x^T (x\theta + n) - \theta = (x^T x)^{-1} x^T n$$

$$E((x^T x)^{-1} x^T n n^T x (x^T x)^{-1}) =$$

$$(x^T x)^{-1} x^T E(n n^T) x (x^T x)^{-1}$$

$$= \sigma^2 (x^T x)^{-1}$$

$$\lim Cov(\hat{\theta}_{LS}) = 0$$

$$\mu(e) = E(e) = E(y - \hat{y}) = E(x\theta + n - y) =$$

$$E(x\theta + n - x\hat{\theta}) = 0$$

$$Cov(e) = E(ee^T) = E(x\theta + n - x\hat{\theta})(x\theta + n - x\hat{\theta})^T = \sigma^2 (I - x(x^T x)^{-1} x^T)$$

The calculation process is as follows:

$$SSE = [y[1] \dots y[N]] \begin{bmatrix} y[1] \\ \vdots \\ y[N] \end{bmatrix}$$

$$- [y[1] \dots y[N]] \theta^T$$

$$-\theta^T \begin{bmatrix} x_1[1] & \dots & x_1[N] \\ \vdots & & \vdots \\ x_n[1] & \dots & x_n[N] \end{bmatrix} \begin{bmatrix} y[1] \\ \vdots \\ y[N] \end{bmatrix}$$

$$- y^T x^T \theta + x^T \theta \theta^T x$$

$$SSE = yy^T - \theta^T x y - y^T x^T \theta + x^T \theta \theta^T x$$

$$\theta_{n*1} = (x^T x)^{-1} x^T y$$

(11)

4.4 Computing Expectation, Covariance, And Statistical Error Behavior For A System

x is non-random variable and n is white noise with zero average and σ^2 is covariance.

$$\begin{aligned} \hat{\theta}_{LS} &= (x^T x)^{-1} x^T y \\ E(\hat{\theta}_{LS}) &= E((x^T x)^{-1} x^T y) = \\ (x^T x)^{-1} x^T E(y) &= (x^T x)^{-1} x^T (x E(\theta) + E(n)) \\ E(n) &= 0 \end{aligned} \tag{12}$$

It can be seen that if white noise with average of 0 appears in the LS estimation, the expectation of estimation is same as real values of the parameter.

Covariance:

$$\begin{aligned} &= \frac{1}{N} \sum ((\hat{\theta} - \mu)(\hat{\theta} - \mu)^T) = E((\hat{\theta} - \theta)(\hat{\theta} - \theta)^T) \\ (\hat{\theta} - \theta) &= (x^T x)^{-1} x^T (x\theta + n) - \theta = \\ (x^T x)^{-1} x^T n \end{aligned}$$

$$\begin{aligned} E((x^T x)^{-1} x^T n n^T x (x^T x)^{-1}) &= \\ (x^T x)^{-1} x^T E(n n^T) x (x^T x)^{-1} &= \\ = \sigma^2 (x^T x)^{-1} & \\ \lim Cov(\hat{\theta}_{LS}) = 0 \end{aligned} \tag{13}$$

Error calculation:

$$\begin{aligned} E(e^T e) &= E(\text{Tr}(e^T e)) = E(\text{Tr}(e e^T)) \\ &= \text{Tr}(E(e e^T)) = \\ \text{Tr}(Cov(e)) &= \sigma^2 \text{Tr}(I - x(x^T x)^{-1} x^T) \\ &= \sigma^2 (n - \text{Tr}(x^T x (x^T x)^{-1})) \\ \sigma^2 &= \frac{Cov(e)}{N - n} \\ E(\hat{Y}) &= E(x \hat{\theta}) = x E(\hat{\theta}) = x \theta = y \\ Cov(\hat{y}) &= E((\hat{y} - x \theta)(\hat{y} - x \theta)^T) \\ &= E(x(\hat{\theta} - \theta)(\hat{\theta} - \theta)^T x^T) = \\ x E((\hat{\theta} - \theta)(\hat{\theta} - \theta)^T) x^T &- x Cov(\hat{\theta}) x^T \end{aligned} \tag{14}$$

Conduct of parameters in LS estimation:

$$\begin{aligned} I(\theta) &= e^T e + \alpha \theta^T \theta \\ \frac{\partial I}{\partial \theta} = 0 &\longrightarrow I(\hat{\theta}) = (y - x \hat{\theta})^T (y - x \hat{\theta}) + \alpha \hat{\theta}^T \hat{\theta} = \\ (x^T x + \alpha I)^{-1} x^T y \end{aligned}$$

$$\begin{aligned} I &= (-\hat{\theta}^T x^T + y^T)(y - x \hat{\theta}) + \alpha \hat{\theta}^T \hat{\theta} \\ \frac{\partial I}{\partial \theta} &= -2 x^T (y - x \hat{\theta}) + 2 \alpha \hat{\theta} = 0 \\ \longrightarrow (x^T x + \alpha I) \hat{\theta} &= x^T y \end{aligned} \tag{15}$$

5 Results of simulation and identification of parameters in a Dena vehicle

5.1 Relationship between fuel consumption, engine temperature and engine speed

Definition of Parameters:

- Fuel consumption: V
- Engine temperature: T
- Engine speed: W

The relationship between parameters is as follows:

$$V = f(T, W) \tag{16}$$

f is considered as a LS estimation of two parameter W and T then modeling errors will be checked.

$$\begin{aligned} V &= f(T, W) \\ y = \theta_1 x_1 + \theta_2 x_2 &\longrightarrow y = V, x_1 = T, x_2 = W \longrightarrow V = \theta_1 T + \theta_2 W \\ \theta = \begin{bmatrix} \theta_1 \\ \theta_2 \end{bmatrix} &= (x^T x)^{-1} x^T y \longrightarrow x^T : 2 * N, x : N * 2, y : N * 1 \\ \longrightarrow \theta &= (x^T x)^{-1} x^T V \\ x = x_1 x_2 &\longrightarrow x = TW \end{aligned}$$

$$\begin{aligned} e &= V_1 - [\theta_1 \quad \theta_2] \begin{bmatrix} T_1 \\ W_1 \end{bmatrix} \\ SSE &= e e^T \\ e &= V_1 - x \theta \\ SSE &= \frac{1}{n} |e|^2, n = size(V_1) \\ V &= 0.083458T - 0.000417W \end{aligned} \tag{17}$$

5.2 Software Analysis

After storing the data of can network, and separating the frames into signals, through the CAN software, the data is broken down into the required signals as below, and according to the system identification Formula and the LS estimation in the following figure in MATLAB software Coding has been done and it is observed that an error value is obtained 0.0654, so this kind of estimation was so much accurate and the error value is near to 0. By using the estimated value, a new signal is obtained which is an estimate of the real signal. It can be said that the sum of squares was presented, with estimates approximately equal to real values, and the sum of squares was close to zero.

Gasoline_Tank_Level_By_EV45%	Fuel_Consumption%Brake	Pedal_GearEngaged	Engine_Coolant_Temperature	Engine_Speed_RPM	Wheel_Pulse_Counter_FL	Wheel_Speed_FL
13.496	0	87	2200			4329816
6.889375	1					4329802
						4329847
						4329901
6.889375	0	87	2240			4329946
						4330004
13.496	1					4330060
6.889375	0	87	2240			4330112
						4330166
						4330214
6.889375	1					4330266
						4330318
						4330366
6.889375	0	87	2205			4330416
						4330466
						4330512
13.496	1					4330562
6.889375	0	87	2211			4330612
						4330662
						4330712
6.889375	1					4330762
						4330812
						4330862
6.889375	0	87	2190			4330912
						4330962
						4331012

Figure 19. Excel File Of Separated Signals (data acquisition)

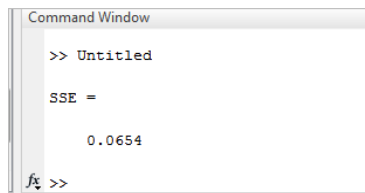

Figure 20. Excel File Of Separated Signals

6 Conclusion

Hear the Relationship between fuel consumption, engine temperature and engine speed based on LS estimation for Iranian vehicles with data that was logged from a DENA CAR for identification of performance and network of cars was checked. The proposed controller could estimate an algorithm for different parameter of car in comparison to each other but the value of error was not zero. The minimum squared value is close to zero and not zero, which means that the estimated value is not exactly equal to the actual value. The results show that the system for having a better performance may need a nonlinear control like fuzzy controller.

The exact identification and modeling of complex systems is very difficult and impossible in some cases, requires the precise modeling of the systems and their interactions, which in some cases, even if possible, is very time consuming and costly. Usually Fuzzy models increase the ability to recognize and diagnose faults for complex systems, in the absence of

sufficient information, as well as in cases where measurements have less relative accuracy.

Fuzzy algorithms, although due to their specific structure, do not face complex mathematical equations, but they need to have a strong knowledge base. This knowledge can include expert knowledge, empirical studies, and technical specifications of the existing system.

References

- [1] Xiaoguang Di ; Chuangzhou Hao ; Jun Che ; Zhiyong Tan ; Silun Zhang, "Comparison on the anti-windup control methods of air-breathing hypersonic vehicle," Proceedings of the 33rd Chinese Control Conference.2014
- [2] Fazal U. Syed ; Ming L. Kuang ; Matt Smith ; Shunsuke Okubo ; Hao Ying, "Fuzzy Gain-Scheduling Proportional-Integral Control for Improving Engine Power and Speed Behavior in a Hybrid Electric Vehicle" IEEE Transactions on Vehicular Technology.2009
- [3] I. Boniolo ; S.M. Savaresi ; M. Tanelli ; IET Control Theory & Applications "AN innovative method for estimating the roll angle two-wheeled vehicles is proposed ," IET Control Theory & Applications.2009
- [4] Xiangui Liu 2008 7th World Congress on Intelligent Control and Automation Integrated Control of automobile steering and suspension system for disturbance suppression
- [5] LiQiang Jin and Yue Liu, "Study on Adaptive Slid Mode Controller for Improving Handling Stability of Motorized Electric Vehicles," IEEE. 1-4244-1259 -2014
- [6] Massimo Canale, Lorenzo Fagiano, "Vehicle Yaw Control via Second-Order Sliding-Mode Technique. IEEE Transaction on Industrial Electronic," VOL. 55, NO. 11-2008.
- [7] Jong Hyeon P, Woo Sung A, "H[∞] yaw 2 moment control with brakes for improving driving performance and stability," [C] USA, 1999, 9: 7472752.
- [8] Li, Bin, Daofei Li., and Fan Yu, "Vehicle Yaw Stability Control Using the Fuzzy-Logic Controller," IEEE. 1-4244-1266.2007.
- [9] Kiumars Jalili, "Stability Control of Electric Vehicles With In-Wheel Motors," Doctoral

thesis, University of Waterloo, Ontario, Canada 2010.

- [10] Li Zhai, Tianmin Sun and Jie Wang, "Electronic Stability Control Based on Motor Driving and Braking Torque Distribution for a Four In-Wheel Motor Drive Electric Vehicle," IEEE DOI 10.1109/TVT.2016.2526663.
- [11] L. A. Zadeh, ". Fuzzy sets. Information And Control," 8(3), 338–353. 1965.
- [12] Hamid Taghizadeh, "Introduction To Automation And Industrial Process Control, In Persian" 1381
- [13] Hesamoddin Fatahiyan, "Industrial Automation and Communication Networks, In Persian" Information Officer of the General Directorate of Technical and Professional Training of Hamedan
- [14] Hoggat sabzpooshan, "Principles and Components of Industrial Control, In Persian" Iran University of Science & Technology
- [15] Mohammad Reza Naggashzadeh, "CAN Communication Protocol and its Application In The Car, In Persian" Islamic Azad University, Dezful Branch
- [16] Mohammad Reza Ahadiat and Hosein Dehghan, "Examining And Comparing The Two Protocols, VAN, CAN In The Electric Steering System of Internal Production Vehicles, In Persian " Yazd Azad University
- [17] Mohammad Reza Maher and Ahmad Heidarian, "Fieldbus Technology And Its Applications, In Persian" 1381
- [18] SPCO, "Database of CAN network for Internal automobiles in Iran Khodro Company, In Persian"
- [19] Lennart, Ljung, "SYSTEM IDENTIFICATION Theory for the User, "University of Linköping Sweden
- [20] R.ISERMANN, Darmstadt, Federal Republic of Germany "SYSTEM IDENTIFICATION Tutorials presented at the 5th IFAC Symposium on Identification and System Parameter Estimation, "1979
- [21] P.M.J Van den HOF, B.WAHLBERG and S.WEILAND "SYSTEM IDENTIFICATION A Proceedings volume from the 13th IFAC Symposium on System Identification, "2003
- [22] SARA A.VAN DE GEAR " Least Squares Estimation, Encyclopedia of Statistics in Behavioral Science"2005